

Article number: 3901044010200

Description: Worm gear with solid input shaft
VF 44A-10-HS

Measures

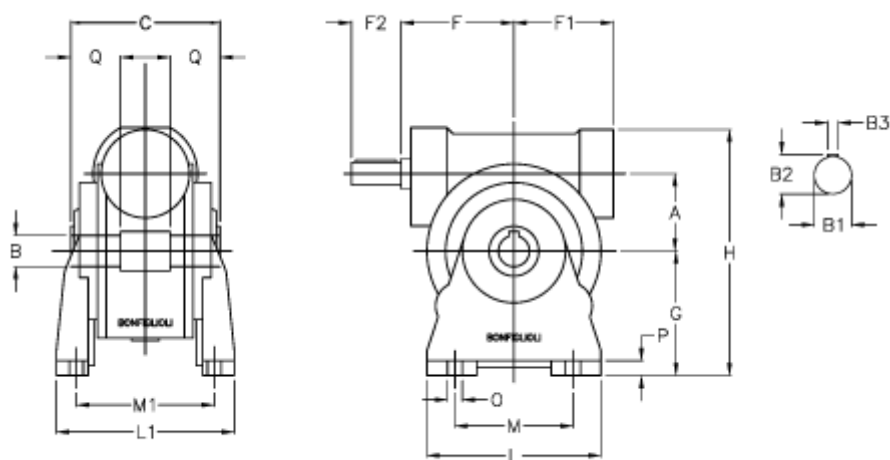

a	= 44.6	F1 = 54	P = 10
B	= 18	g = 72	Q = 24.5
B1 E7	= 11	H = 143	
B2	= 12.5	L = 90	
B3 H9	= 4	L1 = 98	
C	= 64	m = 52	
Description = VF 44A-xx-HS	M1 = 81.0		
F	= 54.0	O = 8.5	